

MAGICFX[®] SWIRL FAN

PRODUCT CODE : MFX0701/MFX0702
VERSION : 1.0
DATE : 16.01.2018



1. CONGRATULATIONS!

You have bought a great new product from MAGICFX®.

MAGIC FX is a Dutch manufacturer of professional special effects machines and equipment. We have been experts in special effects since our establishment in 1995. All our products are made under the brand name MAGICFX® which by now has acquired a great reputation on account of its quality and reliability. All products are made in accordance with the European Machinery Directive. MAGIC FX manages the entire production process in-house, from the design stages and prototyping to production. In short, we cover everything from concept to ready-to-use product.



Moreover, MAGIC FX is Europe's largest supplier of high-quality and fireproof confetti products and streamers. Thanks to our very large stock levels, we can deliver quickly and at low prices.

MAGICFX® is used by special effects professionals all over the world and our products are distributed through a dealer network which covers more than 80 countries.

Congratulations and enjoy your purchase!

MAGICFX®

2. CE MARKING

	<p>PLEASE NOTE: We presume that you, your employees and others who use or come into contact with the machine are familiar with how the machine must be dealt with. This includes the correct use, maintenance and repair of the machine as described in this user manual. This also means that the employees are familiar with the use of machines through training or experience.</p>
	<p>DANGER WARNING: Only use the Swirl Fan (XL) in accordance with the regulations and instructions in this manual. Consult MAGIC FX in case of doubt.</p>

Disclaimers:

MAGIC FX B.V. excludes liability for unsafe situations, accidents and damage that are the result of:

- Disregard for the warnings or regulations as set out on the Swirl Fan (XL) or in this documentation.
- Use for other purposes or under other circumstances than those set out in this documentation.
- Alterations to the Swirl Fan (XL). This also includes the use of replacement parts other than the original ones.
- Insufficient maintenance.
- Unauthorised removal of safety caps and/or safeguards.
- Incompetent operation of the machine.

MAGIC FX B.V. is not liable for any consequential loss in the event of a Swirl Fan (XL) breakdown.

© Copyright 2012

All rights are reserved. Nothing from this manual may be duplicated, or kept in an automated data file, or made public, or in any form or manner, whether electronically, mechanically, by photocopying, by incorporation, or in any other manner duplicated without the permission of MAGIC FX B.V.

MAGIC FX at all times retains the right to make alterations without the direct knowledge of the client. The contents of this user manual can also be changed.

Please contact the technical department of your supplier for extra information with regard to, for example, maintenance and repair. This user manual has been drawn up with the utmost care. MAGIC FX cannot be held responsible for any mistakes made in this publication or for any consequences thereof.

3. DECLARATION OF CONFORMITY

DECLARATION OF CONFORMITY
(according to Annex II.1.A of the Machinery Directive)



Concerning the Machinery Directive.
We; MAGIC FX B.V.
Schouwrooij 27
5281 RE Boxtel
The Netherlands

State under personal responsibility:
We are the manufacturer of the product:

MF0701 - MAGICFX® Swirl Fan
MF0702 - MAGICFX® Swirl Fan (XL)

to which this statement relates and which is in accordance with the provisions of the following Directive(s):

- Machinery Directive 2006/42/EC

The following harmonising standards have been applied:

- NEN-EN-ISO 12100
- NEN-EN-ISO 60204-1

Place : Boxtel
Date : 15-10-2012

Name: MAGIC FX

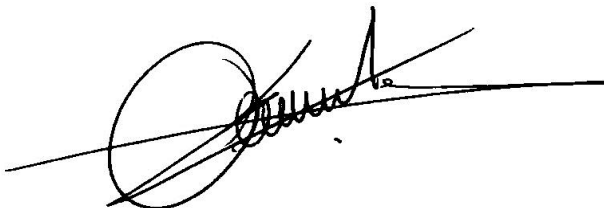

Director: B. Veroude

4. FOREWORD

This manual describes the MAGICFX® Swirl Fan (XL). The information in this manual is important for the proper and safe functioning of the Swirl Fan (XL). If you are not familiar with the installation, operation, preventative maintenance etc. of the Swirl Fan (XL) then please read this user manual carefully from beginning to end. MAGIC FX also insists that all new users (operators, installers, maintenance workers and cleaners) receive a training course in which this user manual can serve as a starting point.

MAGIC FX advises that the original of this user manual, including appendices, is kept at a safe and central place. It is best that another original or copy is kept close to the Swirl Fan (XL) at the workplace.

If you are familiar with these matters, then you can use this manual as a work of reference.

The following standard markings are used in this manual for drawing attention to certain subjects or actions.





	<p>TIP: Gives you suggestions and advice regarding easier or more convenient ways to carry out certain tasks.</p>
	<p>PLEASE NOTE: A comment with additional information: alerts you to certain problems.</p>
	<p>CAUTION: The machine can be damaged if you do not follow the procedures carefully.</p>
	<p>DANGER WARNING: You can get (seriously) hurt if you do not carefully carry out the procedures.</p>

TABLE OF CONTENTS

1.	CONGRATULATIONS!	1
2.	CE MARKING.....	2
3.	DECLARATION OF CONFORMITY	3
4.	FOREWORD	4
5.	INTRODUCTION	6
5.1	DESCRIPTION AND APPLICATION OF THE SWIRL FAN (XL)	6
5.2	NECESSARY ACCESSORIES	6
6.	SAFETY.....	7
6.1	INTRODUCTION	7
6.2	GENERAL SAFETY RULES.....	7
6.3	WARNINGS.....	8
7.	PARTS.....	10
8.	PREPARATION FOR USE.....	11
9.	INSTALLATION	12
10.	USAGE	14
11.	TURNING OFF	15
12.	TROUBLESHOOTING	16
13.	TECHNISCAL SPECIFICATIONS.....	16
14.	MAINTENANCE	16
15.	GUARANTEE	16

5. INTRODUCTION

5.1 DESCRIPTION AND APPLICATION OF THE SWIRL FAN (XL)

The Swirl Fan (XL) is designed to spread confetti from above a stage, catwalk or dance floor. The Swirl Fan (XL) must be mounted in a truss construction and is only suitable for spreading tissue paper or metallic PVC confetti of MAGIC FX.

The Swirl Fan (XL) can be hung in truss, scaff or other systems. The Swirl Fan (XL) operates at 230V~50-60Hz and can be regulated.

Any use other than that described above excludes your supplier from any liability.

5.2 NECESSARY ACCESSORIES

The following parts belong to the Swirl Fan (XL):

		
<p>Manual</p>	<p>IEC Cable (included)</p>	<p>Confetti</p>

Table 5.1

6. SAFETY

6.1 INTRODUCTION

The Swirl Fan (XL) has been designed and constructed in such a manner that it can be used safely. This applies to the use, the circumstances and the regulations as described in this documentation. Reading this documentation and following the instructions are therefore necessary for everyone who is authorised to work with the Swirl Fan (XL).

The Swirl Fan (XL) must be placed and used in surroundings that preferably:

- Have a reasonably stable temperature of between 0 and 30°C.
- Have a relative humidity degree of no more than 75%.
- Are reasonably free of dust, corrosive gases and high concentrations of organic vapours.
- Are not situated in the vicinity of a source of vibration.

6.2 GENERAL SAFETY RULES

- Make sure that children, unauthorised people and animals do not obtain access to the Swirl Fan (XL)!
- Safety devices may not be removed or disabled.
- All required safety devices must be in good condition and function properly.
- Ensure sufficient lighting of the surroundings.
- Keep the workplace clean.
- Only authorised persons may carry out work with the Swirl Fan (XL).

6.3 WARNINGS

Warning texts have been attached to the Swirl Fan (XL). With regard to these the following rules apply:

- These texts may not be removed or damaged. The operator must regularly check if this is the case.
- The operator must ensure that the texts are and remain clearly visible and legible.

	<p>DANGER WARNING: One must replace texts or signs if these are absent, damaged or illegible.</p>
-----------------------------------------------------------------------------------	--------------------------------------------------------------------------------------------------------------

Sign and explanation	Photo
 <p>PIC 616 Follow the instructions</p>	
<p>The operator must be told that he/she may only operate the Swirl Fan (XL) after reading the user manual.</p> <p>A warning is given for this by means of the command sign of PIC 616. This sign should be attached to the type sign. See also the photo.</p>	

Sign and explanation	Photo
 <p>PIC 307 Danger: high voltage</p>	
<p>A warning must be given about the machine's high voltage by using the caution sign PIC 307. This sign must be attached to the Swirl Fan (XL). See also the added photo.</p>	

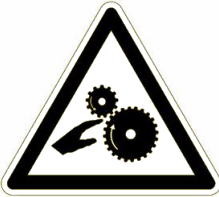
Sign and explanation	Photo
 <p>PIC 334 Warning: rotating parts</p>	
<p>A warning for danger for turning parts (blades of the fan) must be indicated using the PIC 334 icon.</p> <p>This icon is placed on the top of the Swirl Fan (XL).</p>	

7. PARTS

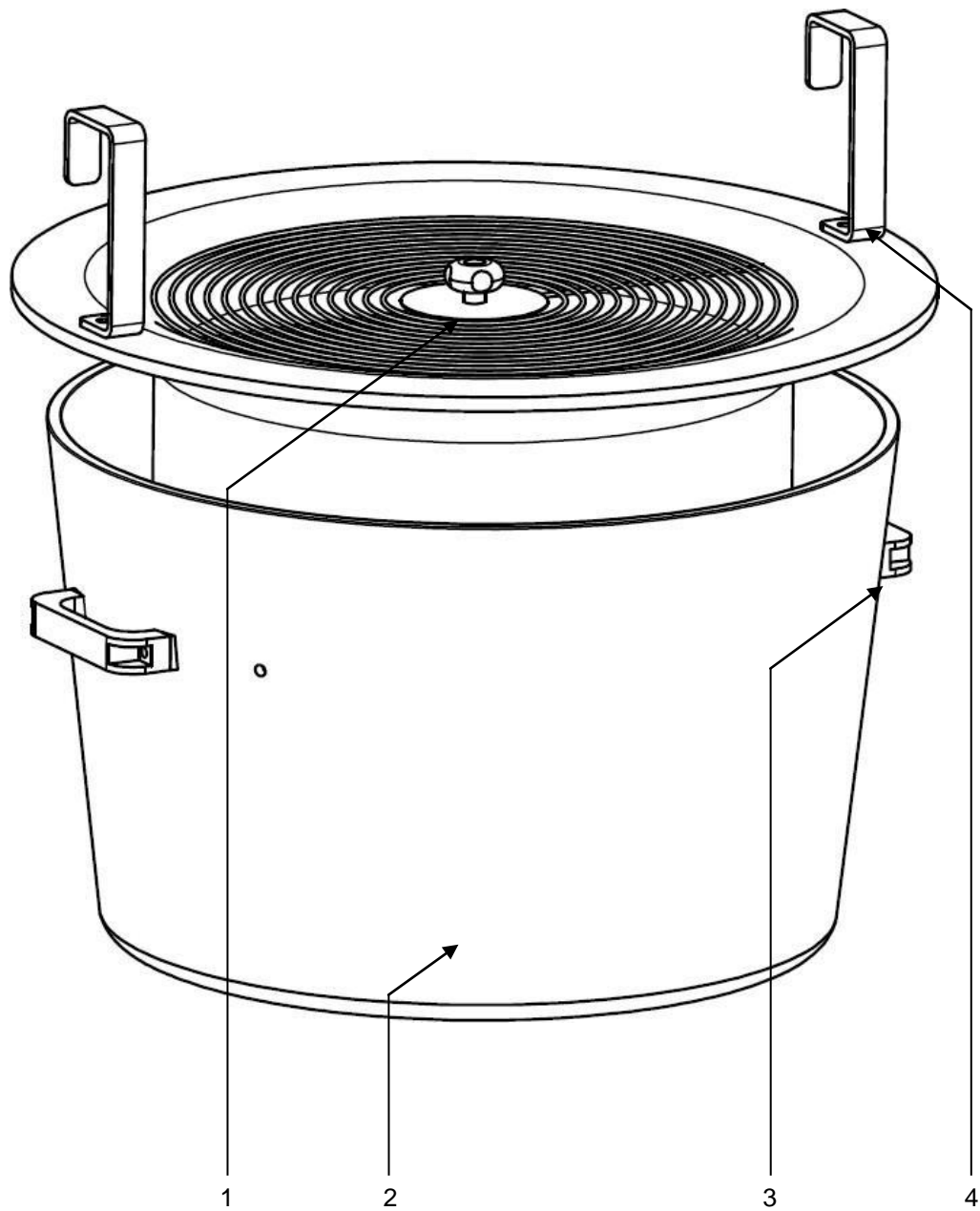



1. Grid mount
2. Confetti reservoir
3. Handle
4. Truss hook

8. PREPARATION FOR USE

Unpack the Swirl Fan (XL). Dispose of packaging material without causing harm to the environment. Check the device for any possible damage. You must report any damage to the device to MAGIC FX.

9. INSTALLATION

	<p>CAUTION: The machine can be damaged, if you do not follow these procedures carefully.</p>
	<p>DANGER WARNING: The MAGICFX® SWIRL FAN (XL) may only be installed by adults and authorised persons. The SWIRL FAN (XL) may only be operated if all parts are completely and correctly installed/connected.</p>

Prepare the Swirl Fan (XL) for use as follows:

1.



Remove the grid by turning the fastener in the left direction and lifting the grid up by hand.

2.



Fill the reservoir of the Swirl Fan (XL) with confetti.



Make sure that the confetti stays under the blades of the fan so the blades are free to move.
If you fill too much confetti, the blades can't move and the motor will be damaged.

3.



Connect a certified safety cable to the safety ring on the motor and connect the other side of the safety cable around the truss so the motor of the machine is secured to the truss.

4.



Place the grid back on the machine and screw on the turn fastener to secure it.

5.



Mount de Swirl Fan (XL) in a truss construction and make sure the truss clamps are connected tightly.

Connect the safety cable which is attached to the motor to the truss.

6.





Connect an IEC power cable to a 230V Switch or to a dimmer.



If you are using a dimmer, carefully read the manual of the dimmer manufacturer.

10. USAGE

	<p>TIP: Gives you suggestions and advice regarding easier or more convenient ways to carry out certain tasks.</p>
	<p>CAUTION: The machine can be damaged, if you do not follow these procedures carefully.</p>
	<p>DANGER WARNING: The MAGICFX® Swirl Fan (XL) may only be installed by adults and authorised persons.</p> <p>The MAGICFX® Swirl Fan (XL) may only be operated if all parts are completely and correctly installed/connected.</p>

For using the Swirl Fan (XL) take the following steps:

1a



Push the switch of the 230V on/off controller in the ON position.

The Swirl Fan (XL) will now fan out the confetti at full speed.

1b



If the Swirl Fan (XL) is connected to a DMX dimmer pack:

Open the fader of the installed DMX channel on the DMX controller to control the effect.

By a dimmer you can choose/control the output of confetti.

11. TURNING OFF

Turn off the Swirl Fan (XL) as follows:

1.



Remove the power cable.

Remove the safety cable and take the Swirl Fan (XL) out of the truss construction.

2.



When the machine is disconnected from the power supply, and when the blades are not turning anymore, open the grid to remove remaining confetti.

3.



Place the grid back on the machine again.

12. TROUBLESHOOTING

- **The Swirl Fan (XL) is filled with confetti, and connected to the power supply but there is no confetti coming out.**

Check the level of confetti in the reservoir and make sure the level of confetti is below the blades of the fan so they are free to move.

- **The Swirl Fan (XL) is connected to a dimmer but there is no confetti coming out.**

Make sure that the dimmer is controlling the Swirl Fan (XL) for minimum 20%. When the dimmer is operating at less than 20% the machine doesn't get enough power to start and the motor can damage.

- **The Swirl Fan (XL) still does not work after troubleshooting**

Always contact your dealer or the MAGIC FX technical department if you have any doubts or questions about the operation of or other issues related to the Swirl Fan (XL).

13. TECHNICAL SPECIFICATIONS

Product		SWIRL FAN	SWIRL FAN XL
Dimensions and weight	Length:	500mm (19.7")	630mm (24.8")
	Width:	500mm (19.7")	630mm (24.8")
	Height:	375mm (14.8")	465mm (18.3")
	Weight:	14 Kg (30.9lbs.)	21.5 Kg (47,4lbs)
Power	Input:	AC 230V~50-60Hz	AC 230V~50-60Hz
	Consumption:	240W	460W
	RPM:	1400	1400
Confetti	Paper:	1Kg / 2.2lbs.	3Kg / 6.6lbs.
	Metallic:	2Kg / 4.4lbs.	6Kg / 13.2lbs.

Design and product specifications are subject to change without prior notice.

14. MAINTENANCE

To prolong the life of the Swirl Fan (XL) for as long as possible, you must regularly clean it and test that it functions properly.

Regardless of the reason, contact MAGIC FX if the Swirl Fan (XL) does not work properly



DANGER WARNING:
Never replace parts yourself. Always consult MAGIC FX when needed.

15. GUARANTEE

The MAGIC FX Swirl Fan (XL) has a 3 year factory guarantee.

- The guarantee is annulled should the Swirl Fan (XL) be used for purposes other than intended or for applications that are not listed in the manual.
- The guarantee is annulled should the device be used incorrectly or in a manner contrary to its instructions.
- The guarantee is annulled if the device is altered without the permission of its supplier.

MAG:CFX[®]

WWW.MAGICFX.EU

